

This guide provides basic information for Unitronics' Vision120™.

General Description

V120 OPLCs are micro-OPLCs, rugged programmable logic controllers that comprise an:

- On-board I/O configuration
- Built-in operating panel containing a graphic LCD screen and a keypad

Communications

- All V120 controllers comprise 2 RS232/485 ports
- Certain models comprise a CANbus port

I/O Options

- On-board I/O configuration
Model-dependent; may include digital, high-speed, and analog I/Os
- I/O Expansion Modules
Via I/O expansion port adapter, connect up to 128 additional I/Os per controller



Programming

Write both the HMI and Ladder control application using VisiLogic freeware.



The Vision120 User Guide and the product's technical specification sheet contain additional information. These documents are located on the Unitronics' Setup CD. They may also be downloaded from the Technical Library at www.unitronics.com.

Standard Kit Contents

V120 controller	Programming cable + RS232 adapter
Mounting brackets (x2)	Rubber seal (mounted in back of panel)
I/O connectors (x2)	Unitronics' Setup CD
5-pin CANbus connector and CANbus network termination resistor (CANbus models)	

Danger Symbols

When any of the following symbols appear, read the associated information carefully.

Symbol	Meaning	Description
	Danger	The identified danger causes physical and property damage.
	Warning	The identified danger could cause physical and property damage.
Caution	Caution	Use caution.



- Before using this product, the user must read and understand this document.
- All examples and diagrams are intended to aid understanding, and do not guarantee operation. Unitronics accepts no responsibility for actual use of this product based on these examples.
- Please dispose of this product according to local and national standards and regulations.
- Only qualified service personnel should open this device or carry out repairs.

 Failure to comply with appropriate safety guidelines can cause severe injury or property damage.



- Do not attempt to use this device with parameters that exceed permissible levels.
- To avoid damaging the system, do not connect/disconnect the device when power is on.

Environmental Considerations

- 
 - Do not install in areas with: excessive or conductive dust, corrosive or flammable gas, moisture or rain, excessive heat, regular impact shocks or excessive vibration, in accordance with the standards given in the product's technical specification sheet.
- Ventilation: 10mm space required between controller's top/bottom edges & enclosure walls.
- 
 - Do not place in water or let water leak onto the unit.
 - Do not allow debris to fall inside the unit during installation.
 - Install at maximum distance from high-voltage cables and power equipment.

Mounting

Dimensions

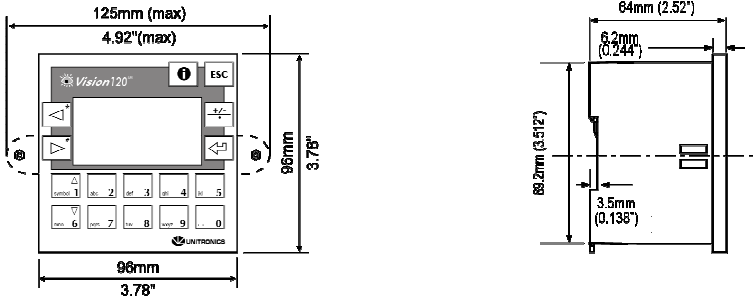

Panel mounting

Before you begin, note that the mounting panel cannot be more than 5 mm thick.

1. Make a panel cut-out measuring 92 x 92 mm (3.622" x 3.622").
2. Slide the controller into the cut-out, ensuring that the rubber seal is in place.
3. Push the 2 mounting brackets into their slots on the sides of the controller as shown in the figure to the right.
4. Tighten the bracket screws against the panel. Hold the bracket securely against the unit while tightening the screw.
5. When properly mounted, the controller is squarely situated in the panel cut-out as shown in the figure to the right.

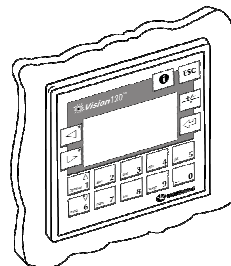
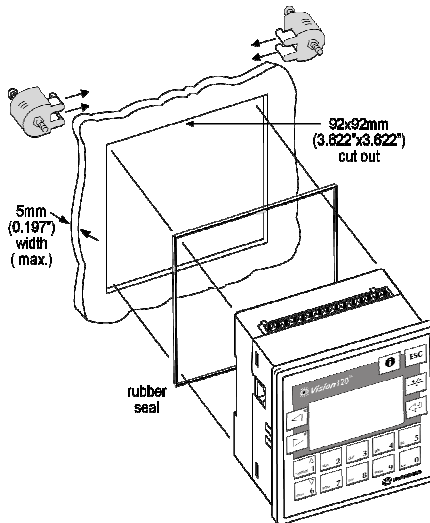

DIN-rail mounting

1. Snap the controller onto the DIN rail as shown in the figure to the right.

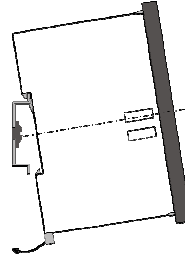

2. When properly mounted, the controller is squarely situated on the DIN-rail as shown in the figure to the right.

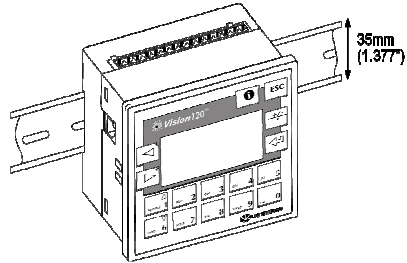

I/O Modules

The controllers offer an on-board I/O configuration that differs according to the controller model; I/O wiring diagrams are in the controller's technical specification sheet.

Additional I/Os may be integrated into the system via I/O Expansion Modules that you plug into the controller's I/O expansion port. Note that the relevant wiring diagrams are in the module's technical specification sheet, and that an I/O adapter is required for most modules.

Wiring: General



- Do not touch live wires.



- Unused pins should not be connected. Ignoring this directive may damage the device.

Caution

- To avoid damaging the wire, do not exceed a maximum torque of 0.5 N·m (5 kgf·cm).
- Do not use tin, solder, or any substance on stripped wire that might cause the wire strand to break.

Use crimp terminals for wiring; use 26-14 AWG wire (0.13 mm²–2.08 mm²).

1. Strip the wire to a length of 7±0.5mm (0.250–0.300").
2. Unscrew the terminal to its widest position before inserting a wire.
3. Insert the wire completely into the terminal to ensure a proper connection.
4. Tighten enough to keep the wire from pulling free.

Power Supply

The controller requires an external 12 or 24VDC power supply, according to the controller model. Exact information may be found in the controller's technical specification sheet.



- A non-isolated power supply can be used if a 0V signal is connected to the chassis.

- You must use an external circuit protection device.
- ⚠ Install an external circuit breaker. Guard against short-circuiting in external wiring.
- Double-check all wiring before turning on the power supply.
- Do not connect either the 'Neutral' or 'Line' signal of the 110/220VAC to device's 0V pin.
- In the event of voltage fluctuations or non-conformity to voltage power supply specifications, connect the device to a regulated power supply.

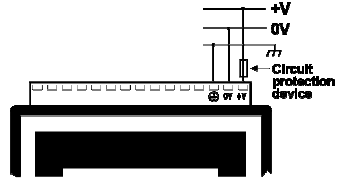

Earthing the Power Supply

To maximize system performance, avoid electromagnetic interference by:

- Mounting the controller on a metal panel.
- Earthing the controller's power supply: connect one end of a 14 AWG wire to the chassis signal; connect the other end to the panel.

Note: The wire used to earth the power supply must not exceed 10 cm in length. If your conditions do not permit this, do not earth the power supply

Communication Ports

This series comprises 2 serial ports that may be set to either RS232 or RS485. Certain models also comprise CANbus ports. Check your controller's technical specifications.

- ⚠ ▪ Turn off power before making communications connections.

- Caution*
- Signals are related to the controller's 0V; the same 0V is used by the power supply.
 - Always use the appropriate port adapters.

Serial Communications

The serial ports are type RJ-11 and may be set to either RS232 or RS485 via jumper as described on page 6. By default, the ports are set to RS232.

Use RS232 to download programs from a PC, and to communicate with serial devices and applications, such as SCADA.

Use RS485 to create a multi-drop network containing up to 32 devices.

- Caution*
- The serial ports are not isolated. If the controller is used with a non-isolated external device, avoid potential voltage that exceeds $\pm 10V$.

Pinouts

The pinouts below show the signals between the adapter and port.

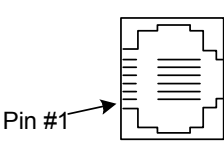
RS232		RS485		Controller Port 
Pin #	Description	Pin #	Description	
1*	DTR signal	1	A signal (+)	
2	0V reference	2	(RS232 signal)	
3	TXD signal	3	(RS232 signal)	
4	RXD signal	4	(RS232 signal)	
5	0V reference	5	(RS232 signal)	
6*	DSR signal*	6	B signal (-)	

*Standard programming cables do not provide connection points for pins 1 and 6.

RS232 to RS485: Changing Jumper Settings

- Ports can be set to either RS232 or RS485 according to jumper settings.
- To access the jumpers, you must open the controller, and then remove the module's PCB board. Before you begin, turn off the power supply, disconnect and dismantle the controller.
- When a port is adapted to RS485, Pin 1 (DTR) is used for signal A, and Pin 6 (DSR) signal is used for signal B.
- If a port is set to RS485, **and** flow signals DTR and DSR are not used, the port can also be used to communicate via RS232; with the appropriate cables and wiring.



- Before performing these actions, touch a grounded object to discharge any electrostatic charge.
- Avoid touching the PCB board directly. Hold the PCB board by its connectors.

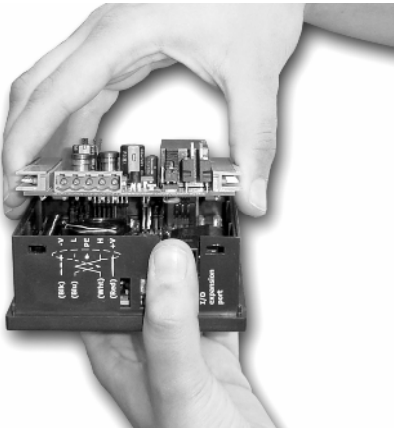
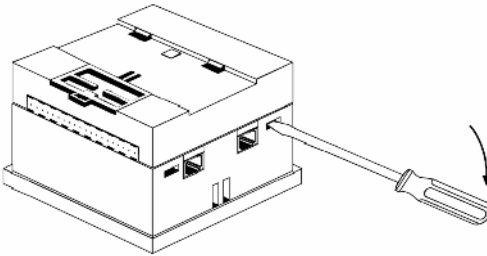

1. Turn power off before opening the controller.
2. Locate the 4 slots on the sides of the controller.
3. Using the blade of a flat-bladed screwdriver, gently pry off the back of the controller.
4. Gently remove the top PCB board:
 - a. Use one hand to hold the top-most PCB board by its top and bottom connectors.
 - b. With the other hand, grasp the controller, while keeping hold of the serial ports; this will keep the bottom board from being removed together with the top board.
 - c. Steadily pull the top board off.
5. Locate the jumpers, and then change the jumper settings as required. Jumper settings are shown on page 7

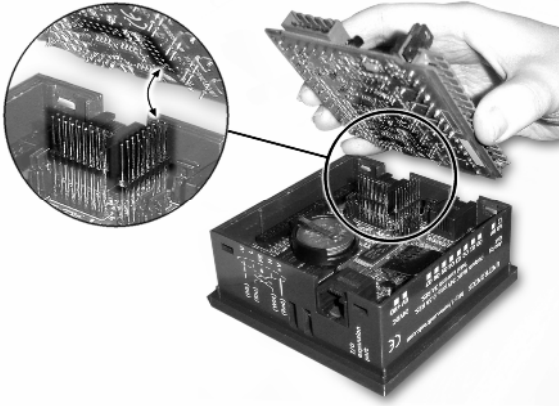

6. Gently replace the PCB board. Make certain that the pins fit correctly into their matching receptacle.
 - a. Do not force the board into place; doing so may damage the controller.
7. Close the controller by snapping the plastic cover back in its place. If the card is placed correctly, the cover will snap on easily.

RS232/RS485 Jumper Settings

	Jumper Settings		
	Jumper	RS232*	RS485
COM 1	1	A	B
	2	A	B
COM 2	5	A	B
	6	A	B

RS485 Termination		
Jumper	ON*	OFF
3	A	B
4	A	B
7	A	B
8	A	B

*Default factory setting.

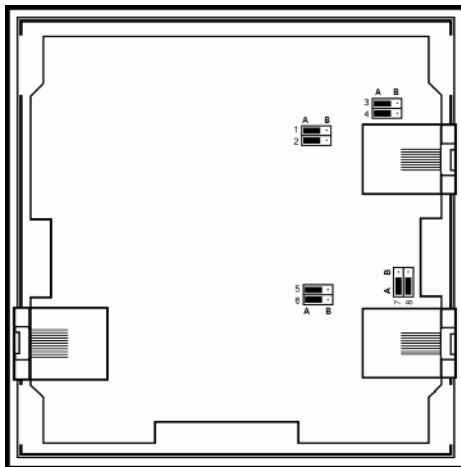

CANbus

These controllers comprise a CANbus port. Use this to create a decentralized control network of up to 63 controllers, using either Unitronics' proprietary CANbus protocol or CANopen. The CANbus port is galvanically isolated.

CANbus Wiring

Use twisted-pair cable. DeviceNet® thick shielded twisted pair cable is recommended.

Network terminators: These are supplied with the controller. Place terminators at each end of the CANbus network.

Resistance must be set to 1%, 121Ω, 1/4W.

Connect ground signal to the earth at only one point, near the power supply.

The network power supply need not be at the end of the network

CANbus Connector

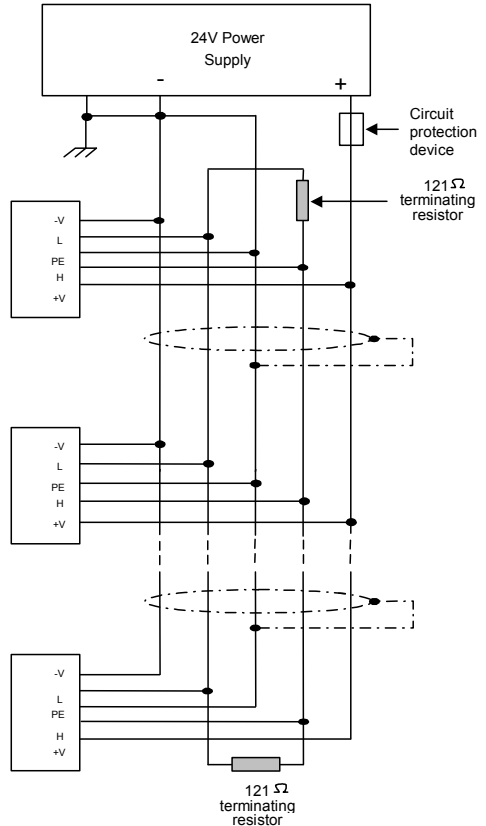
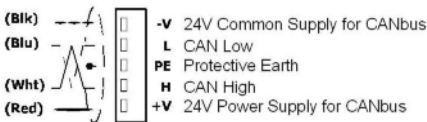

The information in this document reflects products at the date of printing. Unitronics reserves the right, subject to all applicable laws, at any time, at its sole discretion, and without notice, to discontinue or change the features, designs, materials and other specifications of its products, and to either permanently or temporarily withdraw any of the foregoing from the market.

All information in this document is provided "as is" without warranty of any kind, either expressed or implied, including but not limited to any implied warranties of merchantability, fitness for a particular purpose, or non-infringement. Unitronics assumes no responsibility for errors or omissions in the information presented in this document. In no event shall Unitronics be liable for any special, incidental, indirect or consequential damages of any kind, or any damages whatsoever arising out of or in connection with the use or performance of this information.

The tradenames, trademarks, logos and service marks presented in this document, including their design, are the property of Unitronics (1989) (R"G) Ltd. or other third parties and you are not permitted to use them without the prior written consent of Unitronics or such third party as may own them